



A Division of Thiessen Products, Inc.

INSTRUCTION SHEET FOR No. 5400, 5401, 5402, & 5462

The JIMS **FORCEFLOW** CYLINDER HEAD COOLER is designed for Twin Cam Models 1999 - present. Also fits all JIMS Twin Cam Race Engines, and CVO 110 / SE 120R with proper case bolt kit.

NOTE: *These instructions show the installation of this product on a 2012 H-D Road Glide. This is probably the most difficult model to install on. On other H-D Twin Cam models you need to follow the same steps for installation. There are minor differences on other years or models installation. It is highly recommended that you use the correct H-D service manual for reference in this installation. Refer to last page for parts list and for bubble reference callouts.*

OPERATION AND OPTIONS:

The **FORCEFLOW** COOLER comes with a thermostat that actuates at approximately 140 degrees along with an off switch. It is the installer's option to use the thermostat system we've designed and where we recommend you locate it. If you choose to relocate the thermostat, it is your responsibility to mount properly. If you choose not to use the thermostat it is your responsibility to safely disconnect this system. Since JIMS hasn't tested this product with optional changes or locations, JIMS cannot back any warranty issues in this area.

IMPORTANT SAFETY ISSUES:

We have designed the cooler to operate only when the ignition system is turned on by the operator as a safety factor. **DO NOT MODIFY WIRING TO ALLOW COOLER TO OPERATE WITH THE IGNITION IN THE OFF POSITION.**

Warning: KEEP HANDS AWAY FROM MOVING FAN BLADE!

JIMS R&D Dept. tested the Forceflow cooler with a protective shroud around the fan blade and found that it cooled better without a shroud. So with that said do not get your hands etc. near the blade when in operation. **See Fig.A**

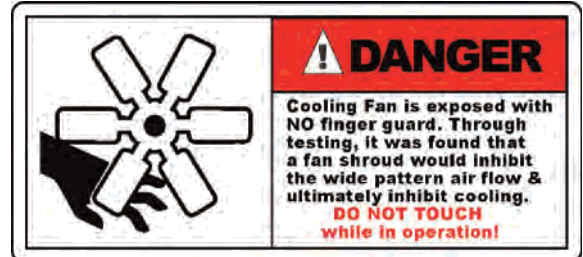

FIG.A



FIG. 1

Installation of the Forceflow Cooler is not intended to be a fix for a poorly tuned, or improperly operating fuel system such as running too lean or rich, causing bluing of pipes or engine damage.

Read the complete instructions before starting the installation of this product.

JIMS cannot be responsible for the safety or quality of your work. If you do not know what you are doing, don't do it. Take it to a professional.

TOOLS AND SUPPLIES RECOMMENDED FOR INSTALLING THE FORCEFLOW COOLER.

1. Common box end wrenches, ratchet, and socket set.
2. Quality ft-lb torque wrench
3. Box cutter or knife to modify the wiring trough.
4. The correct H-D Service Manual per year and model you're working on.
5. Blue Threadlocker.
6. Assorted zip ties.

Performance Parts For Harley-Davidson Motorcycles

555 DAWSON DRIVE, CAMARILLO, CA 93012 PHONE 805-482-6913 • FAX 805-482-9224

VISIT US ON THE WEB AT WWW.JIMSUSA.COM



A Division of Thiessen Products, Inc.

INSTRUCTION SHEET FOR No. 5400, 5401, 5402, & 5462

PREPARATION AND INSTALLATION

1. Remove seat, and disconnect negative battery cable or remove maxi fuse per H-D Service Manual.
2. Remove fuel tank, saddlebags, and side covers per H-D Service Manual.

Note: *The compact design of JIMS Forceflow Cylinder Head Cooler necessitates using a small horn inside the cover for function and aesthetics. Due to the small size of the horn, the tone is not as low as the stock horn. If you are unsatisfied with the tone of the horn, you can relocate the stock horn and use both horns simultaneously. The mounting location will depend on the year and model motorcycle. Some users have relocated the stock horn, without its cover, under the seat or in the nacelle or fairing. The installer must choose the best mounting location for each specific model.*

3. Remove horn assembly with attached bracket per H-D Service Manual. Set aside the horn mounting acorn nut to use for the cooler installation. Leave the rubber isolator and top motor mount on the heads in place as shown. **See Fig 1.**

Caution: Inspect the stock horn rubber isolator mount. This isolator will be used to mount the top of JIMS® Forceflow backing plate. If the horn rubber mount is cracked, worn, or not in serviceable condition, replace only with H-D® No.69123-92A.

4. Remove the top wire harness trough cover to gain access and to place the cooler wiring harness into. **See Fig 2**

5. Next you will need to use a box cutter or knife to cut a notch out of the left side of the plastic harness trough on 2008 and later Touring Models. The notch should be positioned directly above the normal horn position. **When cutting the notch be very careful not to cut any existing wiring.** Notch should be about a 1" square cutout without any rough edges. **See Fig 3**

6. Locate the main wire harness No. 5463 supplied with cooler kit and position it across the top frame rail on top of the existing wiring harness. You need to lay the cooler harness on the left side of the harness trough so that you have the thermostat with bracket and white connector near the original horns location. **See Fig 4.** On the Softail and Dyna models you need to route the harness next to the wiring harness on the top frame rail. To position it correctly you need



FIG. 2



FIG. 3



FIG. 4

Performance Parts For Harley-Davidson Motorcycles

INSTRUCTION SHEET FOR No. 5400, 5401, 5402, & 5462

to have the thermostat drop down to the old horn position. You need to have about a 9" lead hanging out of the harness trough or main wiring harness area as shown to connect horn and cooler wiring.

Note: The wire harness needs to be routed over the top of the top motor mount, not under. This routing will help keep wiring off cylinders when tie wrapped to motor mount in final running position. The other end of the cooler harness with the relay, positive wire, Deutsch connector, & black negative eyelet should be routed back to the battery area. **See Fig 5**

7. Remove the front cylinder rocker box screw as shown. **See Fig 6**
8. Locate the thermostat with mounting bracket on the harness hanging down between the cylinders. Mount the bracket No. 5434 with thermostat using No. 5439 hex head bolt, No. 2014 washer, and spacer No. 5435 to the valve cover as shown. Torque to 15-18 ft-lbs using Blue Threadlocker. At this location the thermostat will activate the fan at approximately 140 degrees. The thermostat mount must be in contact with the rocker box for proper operation. **See Fig 5 and Fig 7.**
9. Remove the center case bolt from the engine case. On a H-D OEM engine case you will have to remove the shifter rod nut and washers at the front gear shifter lever to get clearance to remove the OEM case bolt. **See Fig 8**

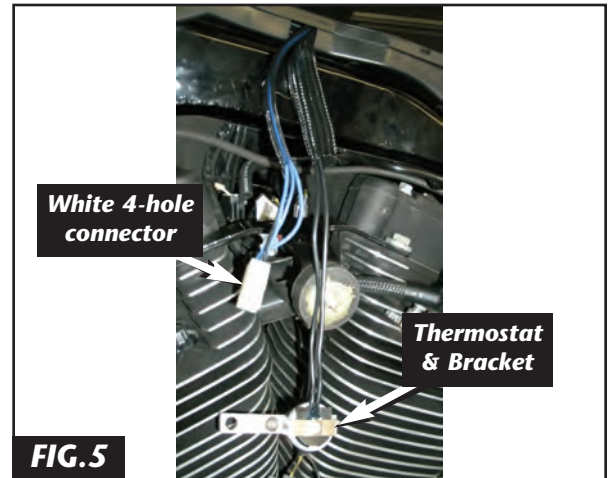

STOCK H-D ENGINE CASES

See Fig 9 Refer to call out bubbles in **Fig 9** and last instruction page parts list for assembly reference.

- A. If your engine cases are factory cases you need to locate the 5/16"-18 case stud No. 5414 provided.
- B. Next lightly coat the threads on the end of stud No. 5414 without the slot on it with Blue Threadlocker.
- C. Insert the coated end of stud No. 5414 into the center case bolt hole and tighten stud snug with a flat blade screwdriver. Slide No.2014 flat washer onto the stud.
- D. Coat I.D. of nut No. 1222 with Blue Threadlocker and thread on and torque to 15-19 ft-lbs using a 1/2" deep socket and torque wrench.
- E. Coat I.D of jam nut No. 5436 with Blue Threadlocker and thread onto the same stud but don't tighten yet.
- F. Next install AN-washer No. 1216 onto No. 5414 stud against jam nut and then No. 5413 lower

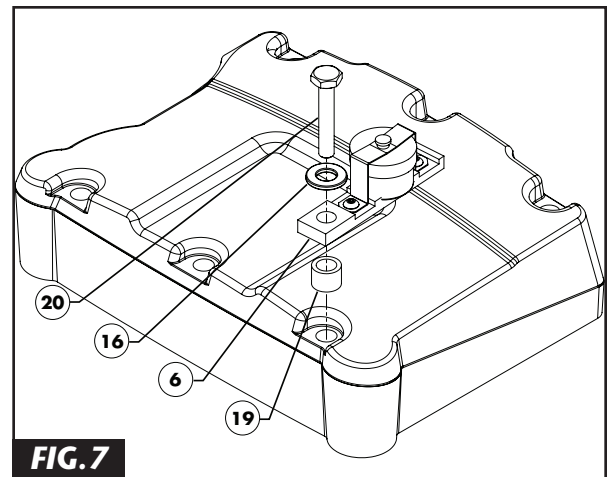

Performance Parts For Harley-Davidson Motorcycles



A Division of Thiessen Products, Inc.

INSTRUCTION SHEET FOR No. 5400, 5401, 5402, & 5462

mount bracket and another No.1216 AN-washer.

- G. Install Blue Threadlocker to I.D. of acorn nut No. 5427 and thread onto the stud.

Before tightening, position the lower bracket in the correct upright position using a box wrench to hold the jam nut No. 5436. Now tighten acorn nut No. 5427 to 8-9 ft-lbs with a 1/2" socket and torque wrench. **See Fig 11**

- H. Now fit up the shifter rod linkage and see if you have adequate clearance when shifting. If your shift rod is hitting on the acorn nut, then swap it out for a normal No. 1222 nut we've provided to gain more clearance. Check clearance again. If that doesn't clear, then move the jam nut inward. Retighten the outside nut and check shift rod clearance. Then re-connect shift rod, washer, and nut. Move on to Step 10.



FIG. 8

JIMS ENGINE RACE CASES

For information on installing this Forceflow cooler kit you should have ordered a No. 5447 JIMS Engine hardware mounting kit. Follow the instructions in that hardware kit to install the special center case bolt hardware. Then proceed back to this 5400-IS instruction sheet and continue on at step No.10.

H-D CVO 110 and SE 120R Models

To mount the Forceflow on H-D CVO 110 or SE 120R models, you will need the JIMS No. 5457 center case stud kit. If you do not have this kit, and have a 110 CVO or SE 120R motor, call (805) 482-6913 and talk to our Sales Department. Follow the instructions included in the hardware kit to install the lower mount for the Forceflow. Proceed to step No. 10 and continue with the 5400-IS instructions.

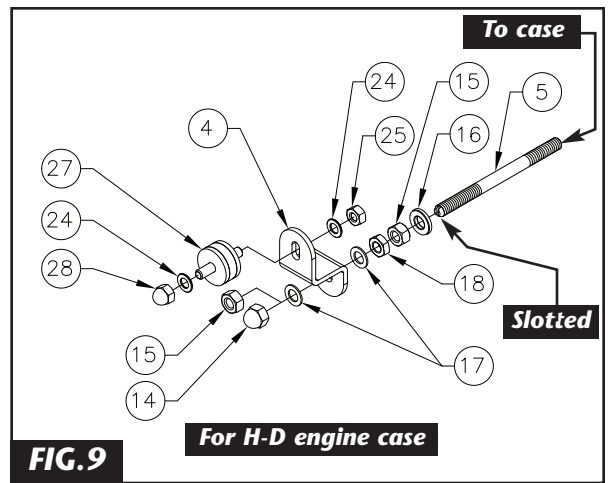

FIG. 9

10. Install No. 5464 isolator with both No. 5466 rubber washers into No. 5413 mount with long end toward the engine. The short end of the isolator has a paint dot on it and should face out. Using blue thread lock, thread No. 5263 flange nut on the backside of the isolator finger tight for now. **Fig 12**
11. Connect the wiring from the cooler housing to the harness before hanging housing on the motorcycle. We suggest you have another person hold the cooler housing while you connect to the two original H-D horns flag connectors hanging down between the cylinders. These are two identical wires coming out of the housing backing plate rubber grommet. **Fig 13**
12. Connect the bikes two existing original horn connectors to the light blue plastic spade connectors from the cooler housing. It doesn't matter what blade goes to which wire. **See Fig 13**
- Note:** For added insulation from weather, position existing shrink wrap and heat as required before doing the final positioning. You may add more shrink wrap if necessary.
13. Next locate the cooler assembly backing plate on both the 1/4" and 5/16" rubber isolator studs. If the assembly looks like its centered great. If you cannot align the upper and lower rubber isolator

Performance Parts For Harley-Davidson Motorcycles

555 DAWSON DRIVE, CAMARILLO, CA 93012 PHONE 805-482-6913 • FAX 805-482-9224
VISIT US ON THE WEB AT WWW.JIMSUSA.COM



A Division of Thiessen Products, Inc.

INSTRUCTION SHEET FOR No. 5400, 5401, 5402, & 5462

studs to the backing plate tab holes without forcing them, then you need to space up the top motor mount bracket. You will need to add one thick washer No. 5453 to each side of top motor mount. Place these washers under the motor mount bracket. Try just one pair of washers first. If needed stack two on each side of mount as shown. **See Fig 1**

14. Locate the other wire coming out of the housing grommet. It has a four pin male white plastic connector that you connect to the cooler harness hanging down from the motorcycles main harness area. **See Fig 5**
15. Connect the two white plastic connectors together. They will only connect when positioned correctly. **See Fig 14**
16. Now its time to do the final positioning of the wire loom in the area behind the cooler assembly and up on the top motor mount to the main loom area.

Note: *It is very important and is the installers responsibility to route and anchor harness wiring away from the cylinders and fan blades. If not done correctly it can cause electrical shorts causing fire, further damage, or bodily harm. If you're not sure about this, take it to a qualified professional. JIMS cannot be responsible for your safety or workmanship.*

Caution: Always check the 3 cover screws for proper torque when installing the Forceflow Cooler assembly. If you remove the cover, be sure to apply blue Loctite to the screws and torque to 90 inch pounds except for the rear screw that goes through the spacer and bumper. Tighten this screw until the bumper just starts deforming, then add one quarter turn. See * Page 8.

17. Do a temporary install of the cooler assembly on the two rubber isolator mounts. Hand tighten your stock H-D horn mount acorn nut on the top larger rubber isolator and No. 5438 acorn nut with No. 5437 washer from kit with to secure assembly.
18. Check wiring coming out of the back of cooler housing and take out any slack by **lightly** pulling on harness going up to the top motor mount area and up to the notched out area of the harness trough. Do a visual check inside cooler to see that all wiring has clearance.

No wiring can come in contact with the fan blade or cylinders. Reposition any extra slack in the harness back to the battery area. Route wiring over top motor mount to trough area and secure by tie



Performance Parts For Harley-Davidson Motorcycles

555 DAWSON DRIVE, CAMARILLO, CA 93012 PHONE 805-482-6913 • FAX 805-482-9224
VISIT US ON THE WEB AT WWW.JIMSUSA.COM

INSTRUCTION SHEET FOR No. 5400, 5401, 5402, & 5462

wrapping for the final operating position.

Caution: Do Not zip tie On/Off switch wires too tight! They need **some** slack to move so they don't break at the switch.

19. Remove the cooler assembly top and lower mounting nuts to apply Blue Threadlocker to both. Install Logo disc No.5426 to the upper isolator mount and then the H-D original horn mount acorn and torque to 7 to 9 ft lbs.
20. Install the lower washer No. 5437 and apply Blue Threadlocker to No. 5438 acorn nut and do a final tightening. For final tightening of lower isolator mount, tighten the outer acorn nut, then back off ¼ turn. On the inner flange nut, tighten, then back off ¼ turn. After the cooler is anchored, take your finger and spin the fan blade to check for clearance. You should have at least 1/4" between cylinder and fan blade. **See Fig 15**
21. Now tuck the cooler harness into the left side of the harness trough. Reinstall the wire harness upper trough cover back in its normal position per H-D Service Manual. On the FXST or FXD models secure the cooler harness wiring with tie wraps.
22. The power connector socket is not installed into the Deutsch connector. If you are installing the Forceflow on a 1999-2013 FLH or 2006-2011 Dyna, it is recommended to access power via the accessory plug located under the seat. Insert the socket terminal into position 1 on the Deutsch connector, install the wedgelock into the connector, and plug into the 4 place accessory connector. On models with a 6 position Data Link Connector, power must be supplied by H-D No.72673-11 electrical connection update kit. This applies to 2011-present Softail and 2012-present Dyna. 2014 and later FLH models require an adapter for accessory power. Use H-D No.69200722 connection update kit to adapt the stock 8 position Molex ACC connector to a 4 position Deutsch connector. The ACC plug location is under the left side cover.

Note: You can also access power from the Data Link Connector (DLC). If DLC connector is used for power, insert the socket terminal into position 4 on the Deutsch connector, install wedgelock, and connect to the DLC plug.

See Fig 16.

23. Locate the negative battery cable and connect the negative wiring eyelet to it. Mount negative battery cable to the battery post as shown. **See Fig 18**

Note: If your vehicle does not have a Deutsch connector, use this wire to tap into any ignition accessory circuit.





A Division of Thiessen Products, Inc.

INSTRUCTION SHEET FOR No. 5400, 5401, 5402, & 5462

24. Pull aside the cooler wire harness relay section and install the ECM caddy cover as per H-D Service Manual. After the caddy cover is in place, lay the relay wire harness section right along the side of the frame as shown. You can anchor it if you like. **See Fig 19**
25. Reinstall the fuel tank, fuel lines, saddlebags and seat per H-D Service Manual.
26. Now you need to take a test ride and get the motor warmed up. Position cooler switch in the on position (forward position is "OFF" and rear is "ON") **See FIG.17**. The easiest way to check temp. is with an infrared thermometer. When your engine heats up enough to bring the top rocker box to approximately 140 degrees the cooler should start up. Do not use a heat gun or any other heat source other than running the engine to get the thermostat hot enough to turn fan on. You will destroy the thermostat. If you find your fan motor is not going on, turn the toggle switch to the other position and see if that starts the fan motor.

Note: If you're a Dealer Service Dept. installing this product for a customer please forward the JIMS Warranty Card to the customer or end user when completing service and advise to complete and mail in.

6 MONTH WARRANTY

JIMS will repair or replace at our option any product found to be defective in materials or workmanship for six (6) months from date of purchase. This warranty does not cover items damaged by accident, misuse, or neglect. Any implied warranties are expressly excluded, and JIMS shall not be liable for any loss of product use, or other consequential or incidental costs incurred by the user of our tools.

FOR WARRANTY

All returns for warranty must authorized by the sales dept. before returning product.

WARNING!!!

REMEMBER TO KEEP HANDS AND ALL OBJECTS CLEAR OF THE SPINNING FAN BLADE WHENEVER FORCEFLOW UNIT IS SWITCHED TO THE "ON" POSITION.

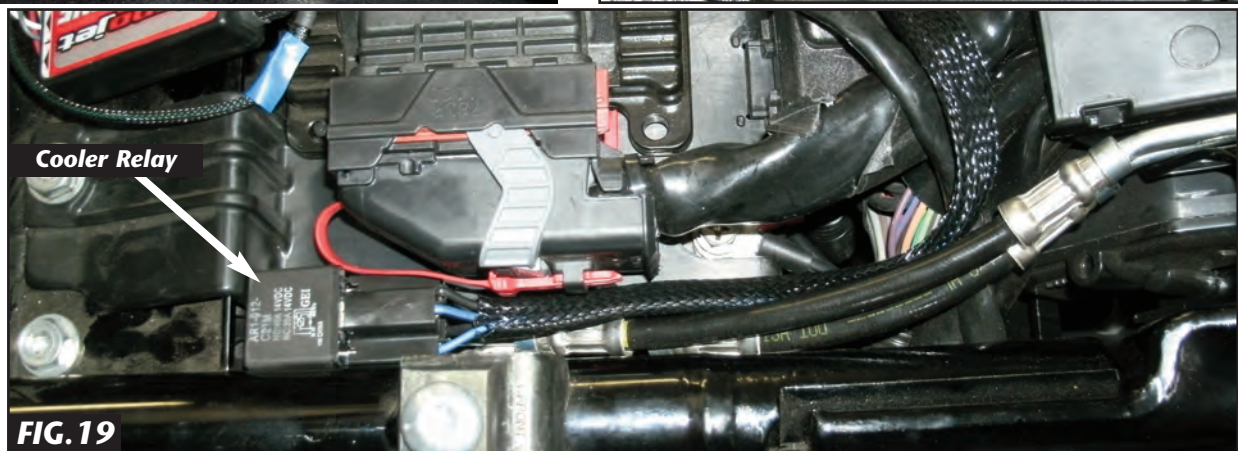
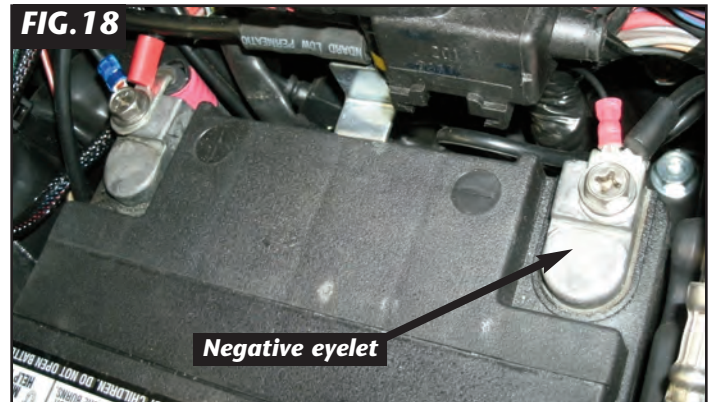
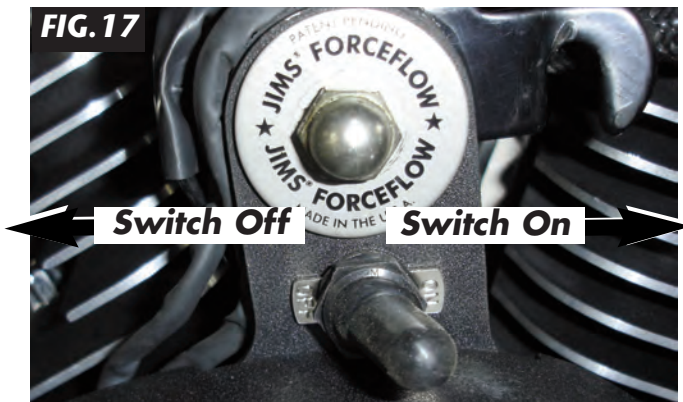



A Division of Thiessen Products, Inc.

INSTRUCTION SHEET FOR No. 5400, 5401, 5402, & 5462

*** Use Blue Threadlocker if removed. Check torque periodically**

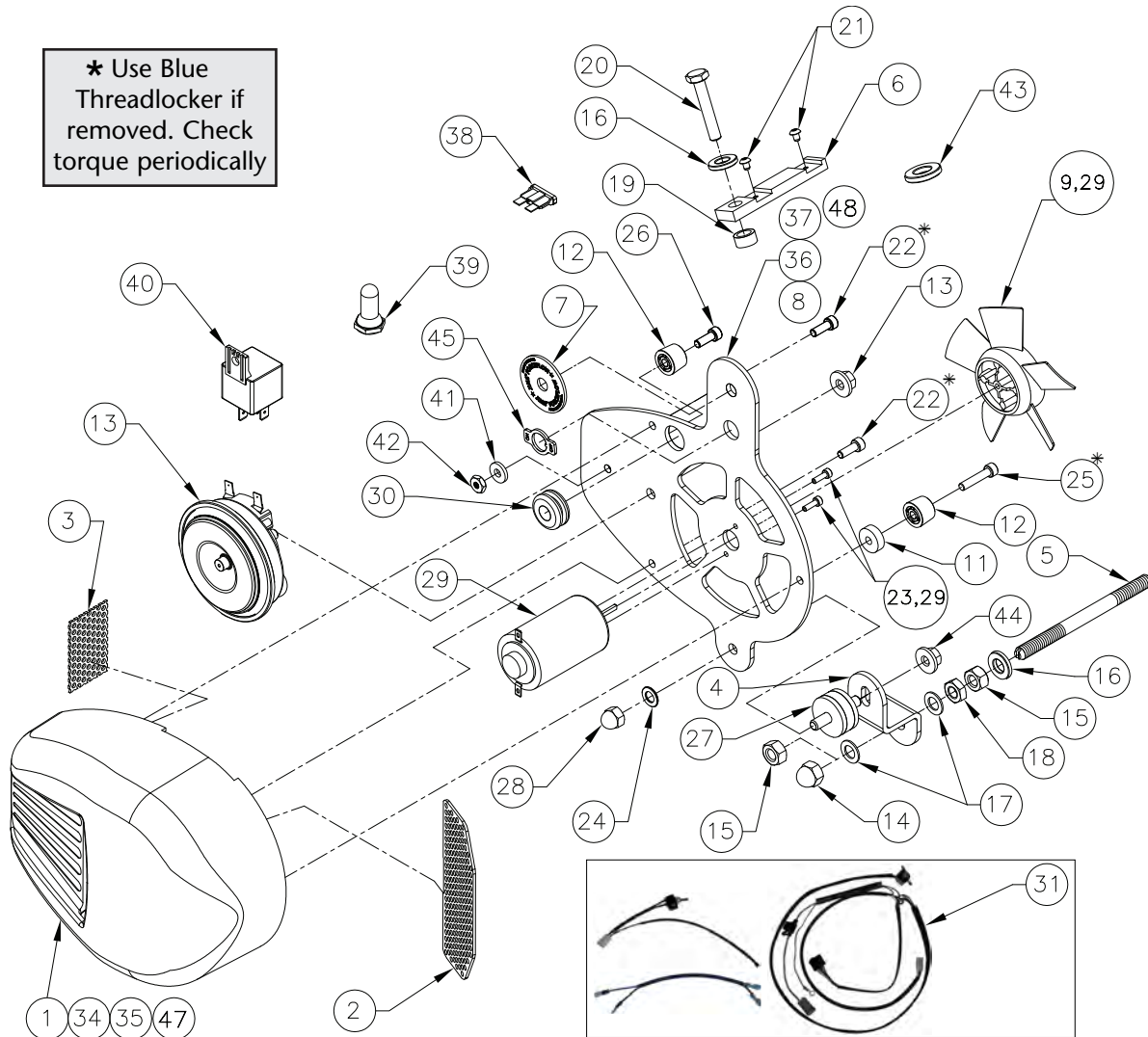

PARTS LIST			
NO.	QTY.	TITLE OR DESCRIPTION	PART NUMBER
1	1	COVER, CYLINDER COOLER, POLISH	5461-2
2	1	SCREEN, SCOOP	5412
3	1	SCREEN, FRONT	5399
4	1	MOUNT, LOWER, MOTOR HD, ZINC	5413
5	1	STUD, CASE, 5/16-18, CYLINDER COOLER	5414
6	1	MOUNT, THERMOSTAT	5434
7	1	PLATE, DISC, LOGO	5426
8	1	BACKING PLATE CYLINDER COOLER, POLISH	5406-2
**	9	1 MACHINED, FAN BLADE	5405
11	1	SPACER WASHER	5452
12	2	BUMPER, HARD THERMOPLASTIC	5451
13	1	HORN, ROOT w/ FLANGE NUT	5410
14	1	NUT, ACORN, 5/16-18, NICKEL PLATE	5427
15	2	NUT, 5/16-18, SAE	1222
16	2	WASHER, FLAT, 5/16", SAE	2014
17	2	WASHER, FLAT, 5/16", AN, .05-.07 THICK	1216
18	1	NUT, 5/16-18, JAM	5436
19	1	SPACER, 5/16 ID x 1/4"	5435
20	1	BOLT, 5/16-18 x 1-1/2" HH	5439
21	2	SCREW, 6-32 x 3/16", BUTTON HEAD	5440
22	2	SCREW, 10-32 x 1/2", SHCS	1294
**	23	2 SCREW, 3mm x .5 x 10mm, SHCS	5421
24	2	WASHER, FLAT, 1/4", AN, .05-.07 THICK	5437

PARTS LIST			
NO.	QTY.	TITLE OR DESCRIPTION	PART NUMBER
*	25	1 10-32 x 7/8" SHCS	5271
26	1	10-32 x 5/8" SHCS	5450
27	1	ISOLATOR, Ø1" x 1/2", 1/4-20 x 1/2"	5464
28	1	NUT, ACORN, 1/4-20, NICKEL PLATE	5438
29	1	MOTOR, / FAN REPLACEMENT KIT	5460
30	1	GROMMET, 3/8" ID x 1/8" PANEL	5418
31	1	WIRING HARNESS MAIN	5463
34	1	COVER, CYLINDER COOLER, BLACK	5461-1
35	1	COVER, CYLINDER COOLER, SILVER	5461-3
36	1	BACKING PLATE CYLINDER COOLER, BLACK	5406-1
37	1	BACKING PLATE CYLINDER COOLER, SILVER	5406-3
38	1	AMT 15 AMP FUSE	5432
39	1	SWITCH BOOT	5417
40	1	RELAY	5422
41	1	#10 FLAT WASHER	5449
42	1	10-32 NUT	1399
43	4	WASHERS, OPTIONAL HORN MOUNT	5453
44	1	NUT, 1/4-20, FLANGE NYLOCK	5263
45	1	ON/OFF SWITCH PLATE	5455
46	1	WARRANTY CARD	5454
47	1	COVER, CYLINDER COOLER, CHROME	5461-4
48	1	BACKING PLATE CYLINDER COOLER, CHROME	5406-5
49	1	INSTRUCTION SHEET	5400-IS

**INCLUDED IN 5460 FAN REPLACEMENT KIT.

Performance Parts For Harley-Davidson Motorcycles

555 DAWSON DRIVE, CAMARILLO, CA 93012 PHONE 805-482-6913 • FAX 805-482-9224

VISIT US ON THE WEB AT WWW.JIMSUSA.COM