



A Division of Thiessen Products, Inc.

INSTRUCTION SHEET FOR TOOL #900

H-D CRUISE DRIVE 6-SPEED MAIN DRIVE GEAR & BEARING REMOVER / INSTALLER TOOL

USE ON ANY H-D 6-SPEED CRUISE DRIVE TRANSMISSION 2006 TO PRESENT

Other recommended JIMS tools for H-D Cruise Drive 6-speed:

- No. **786** *Main seal installer tool*
- No. **989** *Mainshaft pulley locknut socket tool*
- No. **984** *Trap door removal tool*
- No. **911** *Trap door bearing removal tool*
- No. **985** *Shift fork shaft removal tool*
- No. **34902-84** *Mainshaft race remover*
- No. **972** *Main drive gear seal installer tool*
- No. **992** *Modular transmission stand, all Twin Cams*
- No. **899** *Temperature indicating strips*

Recommended H-D® parts as needed:

- No. **8967** *Bearing, Main trans case*
- No. **11161** *Retaining ring*
- No. **12074** *Seal, Main*
- No. **35122-06** *Maindrive gear assembly or No.11201 o-ring and No.12077 seal if re-using main drive gear*

Read complete instructions thoroughly before disassembling or assembling. Refer to figure No.'s, parts list, and photos.

NOTE: IF YOU DO NOT KNOW WHAT YOU ARE DOING, DO NOT DO IT! ALWAYS WEAR SAFETY GLASSES OR OTHER FACE AND EYE PROTECTION SUCH AS A FULL FACE SHIELD. JIMS IS NOT RESPONSIBLE FOR DAMAGE, INJURY, OR THE QUALITY AND SAFETY OF YOUR WORK.

PARTS AVAILABLE SEPARATELY			
No.	Qty.	Description	Part No.
1	1	BEARING REMOVER	900-1
2	1	REMOVAL/INSTALLATION CUP	987-1
3	1	INSTALLER/REMOVER BAR	987-2
4	1	INSTALLER CUP	981-1
5	1	RECEIVER CUP	1720-2
6	1	SCREW, 4" LG.	1456
7	1	SCREW, 8" LG.	2137
8	1	SCREW, 12" LG.	2138
9	1	NUT	2136
10	1	WASHER	2038
11	1	BEARING	2010
12	1	WASHER	1735

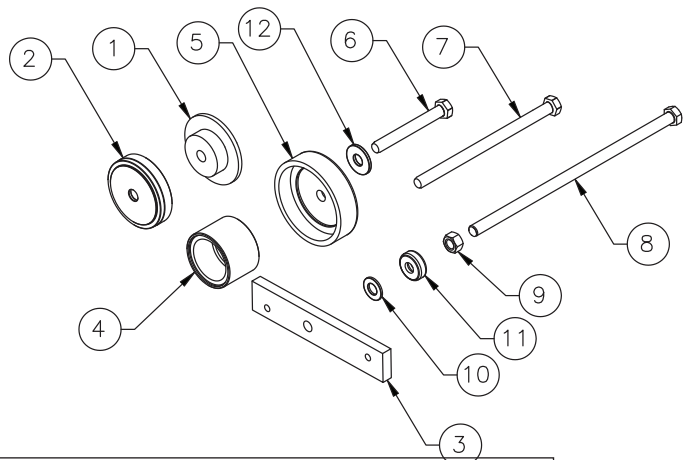

CAUTION: WEAR SAFETY GLASSES OVER YOUR EYES.
SEE JIMS® CATALOG FOR HUNDREDS OF TOP QUALITY PROFESSIONAL TOOLS.
THE LAST TOOLS YOU WILL EVER NEED TO BUY.

Performance Parts For Harley-Davidson® Motorcycles



A Division of Thiessen Products, Inc.

INSTRUCTION SHEET FOR TOOL #900

OTHER RECOMMENDED TOOLS FOR USE WITH THIS TOOL

- | | |
|----------------------------------|----------------------------------|
| 2 - 3/4" Box end wrench | 1 - 1/4" Allen wrench |
| 1- Quality retaining ring pliers | 1- Torque wrench and 3/4" socket |
| 1 - H-D Service manual | |

REMOVING THE MAIN DRIVE GEAR

Note: The main drive gear may be removed from trans case without removing the trans case from frame. The main bearing and retaining ring must be replaced after removal of maindrive gear.

1. Refer to H-D Service Manual for tear down of the transmission assembly to the point of removing the main drive gear.
2. Attach the installation bar tool No. **987-2** to the trap door side of case. Use two allen screws with washers H-D No. **3249** from existing trap door mounting hardware. Locate removal bar No. **987-2** correctly on case using two of the door mounting holes so that the hole is aligned with maindrive gear. The tool bar has been laser marked with "Top" on the tool bar and must face you and be at the top of trans case. **See Fig 1.**

3. Lube threads and install No. **2138** 12" long screw along with No. **1735** washer through center hole of No. **987-1** gear removal cup and into case through the main drive gear. Insert end of 12" screw into tool bar hole No. **987-2**. Now install No. **2010** bearing, No. **2038** washer and lubed No. **2136** nut.

See Fig 2 and 3.

Note: Do not use an impact wrench on this tool. You will cause damage to your tool or transmission case.

Caution: When performing the next step of removing the gear from the bearing you may encounter some resistance beyond what this tool can handle and could damage the case. That is why we recommend you use a torque wrench when removing this gear. If you feel a binding stop and apply heat to the bearing race as shown. Do not exceed 210 degrees. Use No.899 temperature indicating strips so as not to overheat. This should free up the gear. If that doesn't work, it will be your decision on how to extract the main drive gear and bearing. **See Fig 2 & 3**

Note: JIMS cannot be held responsible for any damage caused by not professionally removing the gear or bearing.

4. Use your 3/4" box end wrench and a "ft-lbs torque wrench" to remove gear. Hold No. **2138** screw with the box end wrench while you use the torque wrench with a 3/4" socket on No. **2136** nut. Set the torque wrench at 35 ft lbs and turn No.

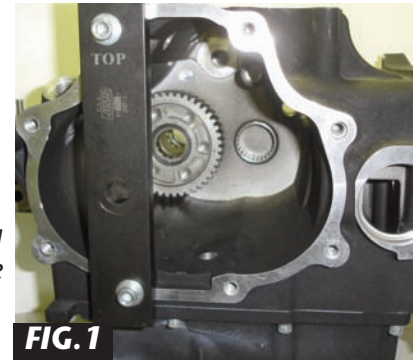

FIG. 1

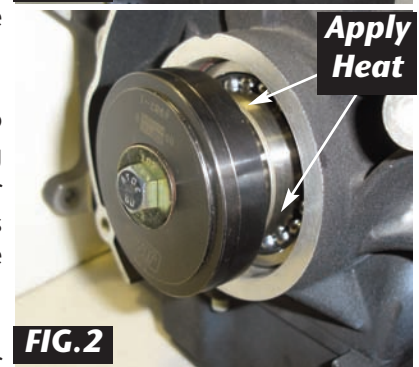

FIG. 2

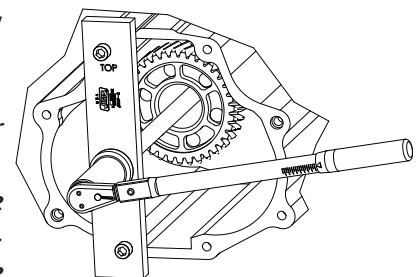

FIG. 3



FIG. 4

CAUTION: WEAR SAFETY GLASSES OVER YOUR EYES.
SEE JIMS® CATALOG FOR HUNDREDS OF TOP QUALITY PROFESSIONAL TOOLS.
THE LAST TOOLS YOU WILL EVER NEED TO BUY.

Performance Parts For Harley-Davidson Motorcycles

INSTRUCTION SHEET FOR TOOL #900

2136 nut clockwise until the main drive gear is pressed out from the bearing.
See Fig 3.

REMOVING THE MAIN DRIVE GEAR CASE BEARING

1. After main drive gear has been removed (if the maindrive gear will be reused, remove bearing race and keep gear clean.)
2. Remove main seal and main bearing retaining ring from bearing bore in trans case per H-D service manual.
3. From inside the case remove the ball bearing cage from the main bearing.
See Fig.4
4. Install No. 1735 washer onto No. 1456 4" long screw and insert through the center of No. 900-1, and position assembly against the main bearing from inside of case. Install the stepped side facing bearing and lube the threads at the end of screw No. 1456 protruding from main bearing. **See Fig 5**
5. Place the 4".screw No. 1456 through No.1720-2 center hole with the cup side facing main bearing on the outer side of the case, followed by bearing No. 2010, No. 2038 washer and then No. 2136 nut threaded on screw end.
See Fig 6
6. Use two 3/4" box end wrenches to remove bearing. Hold No. 2137 screw with one wrench while using the other to tighten nut No. 2136 clockwise until the main bearing is pressed from the case. **See Fig 6**

Note: Hold all tools in alignment with the bearing bore and bearing as you apply torque to the bolt and nut.

INSTALLING THE MAIN DRIVE GEAR CASE BEARING

Note: Before installing a new bearing in trans case, make sure bore is in serviceable condition and the inside of case is washed out.

1. Attach the installation bar tool No. 987- 2 to the trap door side of case. Use two allen screws with washers H-D No. 3249 from existing trap door mounting hardware. Locate bar tool No. 987- 2 correctly on case door mounting holes. The tool bar has been laser marked with "Top" on the tool bar and must face you and be at the top of trans case. **See Fig 7.** Install No. 2138 12" long screw through center hole of No. 987-2 installation tool bar and into case, through the bearing bore. **See Fig 8**
2. Apply a small amount of clean engine oil to the O.D. of new main bearing, then place the new bearing up to its bore, with the protruding race of bearing facing the outside of case. Next place bearing installer tool No. 987-1 with the cup side facing the bearing followed by No. 1720-2 alignment cup, then bearing No. 2010, No. 2038 washer and then No. 2136 nut threaded on screw end.
See Fig 9.

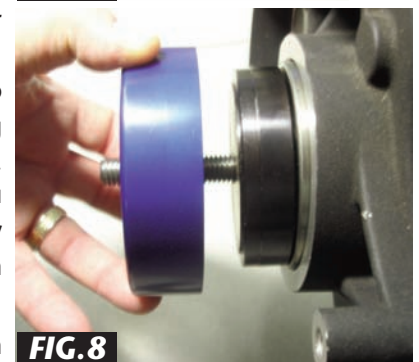
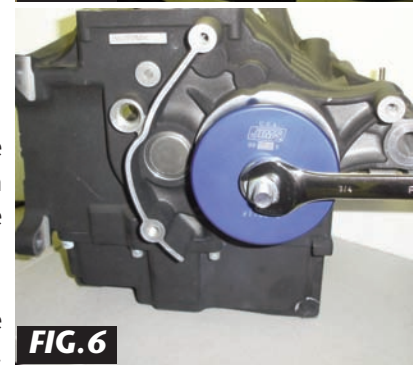

INSTRUCTION SHEET FOR TOOL #900

3. Use two 3/4" box end wrenches to hold No. 2138 screw and other to tighten nut No. 2136 clockwise until the alignment cup No.1720 lightly seats with full contact on the trans case. **See Fig 9.**

4. Now remove the alignment cup No.1720 and reinstall the bearing, washer, and nut against No.987-1 bearing installer. Next torque the No. 2136 nut while holding the No. 2138 screw until the main bearing is pressed straight into the bearing bore and seated. **See Fig 10.**

Note: It should not require more than 35 ft lbs of torque to install the new bearing, check that bearing has bottomed (stops) on the cast lip of trans case.

INSTALLING THE MAIN DRIVE GEAR

1. Install a new o-ring on the main drive gear and apply a small amount of clean engine oil to both sides of o-ring and the I.D. of newly installed bearing. Next Install No. 2137 8" long screw through the center of No. 987-1, with flat side facing bearing then gently place screw No.2137 through maindrive gear and up against the installing cup No.987-1. **See Fig 11**

2. Place this assembly through main bearing. Lube threads at the end of screw No. 2137 protruding from main bearing, followed by installer cup No. 981-1, bearing No. 2010, No. 2038 washer and then No. 2136 nut threaded on screw end. **See Fig 12**

3. Use one 3/4" box end wrench to hold No. 2138 screw while using a torque wrench at the other end to tighten nut No. 2136 clockwise until the maindrive gear is pulled into bearing. **See Fig 12**

Note: It should not require more than 35 ft lbs of torque to install the new maindrive gear, check that maindrive gear has bottomed (stops) on the face of case bearing.

4. Install a new bearing retaining ring with the flat side against bearing, make sure ring is seated 100% in its groove and the opening is at the 3:00 o'clock position with one end at the 2:00 o'clock and the other end is at 4:00 o'clock.

See Fig 13.

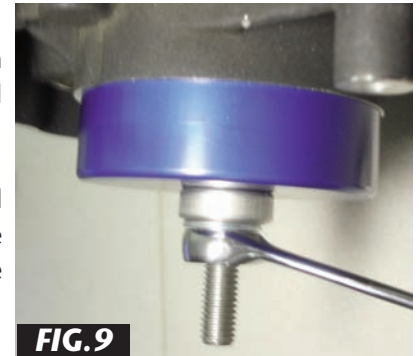

FIG. 9



FIG. 10



FIG. 11



FIG. 13

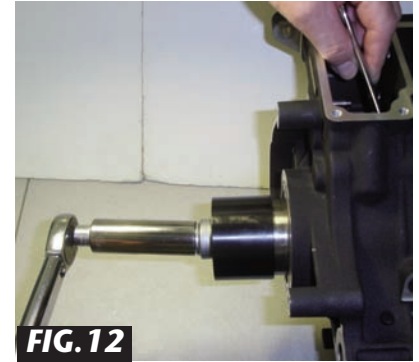

FIG. 12